

SMFVJ • Square Mixed Flow Vertical Jet



Specification

The SMFVJ range of in line-square-cased mixed flow fans shall be constructed with a rigid steel frame. The frame shall be pre-drilled and finished in galvanised steel. The impeller shall be of high efficiency mixed flow design, manufactured in aluminium or high density polymer.

The impeller shall be directly driven by a Ziehl Abegg rotor motor, featuring sealed for life bearings and class F insulation. A thermal contact shall be provided.

Features

- **Powerful** - Ideal for high pressure system
- **Rigid Steel Frame Construction**
 - robust and durable on site
- **Manufactured in Galvanised Steel**
 - can be used internally or externally
- **All Motors are fitted with Thermal Contact Switch incorporated in the Motor Windings**
 - prevents damage due to overloading
- **100% Speed Controllable** - 1 or 3 phase
- **9 Models** - wide choice
- **Simple Wiring** - quick and easy to install
- **Wide Range of Ancillaries** - av's, flanges, silencers & feet

TYPE SMFVJ • In Line Square Cased Mixed Flow Fans

Product Installation & Maintenance Instructions

The square cased mixed flow range of fans consists of 9 duty sizes with a maximum flow rate of 3.75 m³/s. The units are manufactured from galvanised sheet steel to BS. 2989. 1982. The fan is designed to operate in atmospheres up to 95% RH and ambient temperatures up to 70°C

Handling

Always handle the units carefully to avoid damage and distortion. Care must be taken to ensure that any slings used for hoisting do not pass through the impeller.

Fan installation

Installation must be completed by competent persons, in accordance with good industry practice and should conform to all governing and statutory bodies i.e. IEE, CIBSE, COHSE etc.

The units can be installed at any angle and are suitable for internal or external use. The fans are designed to be bolted into proprietary ductwork and the method chosen is the responsibility of the installer.

Electrical

Check that the fan details on the rating plate correspond with the supply voltage and frequency. Motors are designed for Direct On-line starting. Motor overloads should be set to the full load current on the fan rating label. Supply fuses should be H.R.C. type. The units incorporate a terminal box on the casing exterior. Units for external use require weatherproof conduit and glands.

Start up Procedure

Note! The single phase rotational direction is set at works and should NOT be altered. For 2 phase units, check that rotation is correct, if not, interchange 2 phases Equipment should be run for approximately 30 minutes to ensure correct operation.
If a fault occurs, switch off. Do NOT restart until fault has been rectified.

Maintenance

Electrically isolate before commencing work. The first maintenance should be carried out three months after commissioning. Inspect and clean the impeller and motor assembly with care. The motors are fitted with sealed-for-life bearings and do not require any further lubrication.

One Year Warranty

The 1 year warranty starts from the day of delivery and includes parts and labour for the first year. This warranty is conditional on maintenance being carried out after the first 3 months.

WIRING DIAGRAM No. 104 XA
Single phase motor with capacitor and thermal contacts.

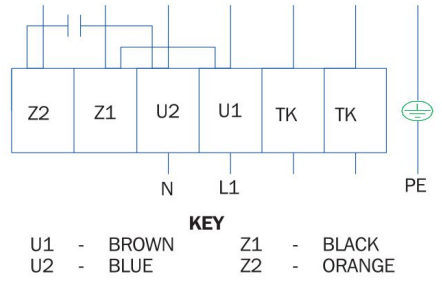

WIRING DIAGRAM No. 106 XA
3 phase motor with single speed and thermal contacts. Rotation is reversed by changing the supply connection of any 2 phases. Please note the arrow for direction of rotation on the impeller or the fan case.

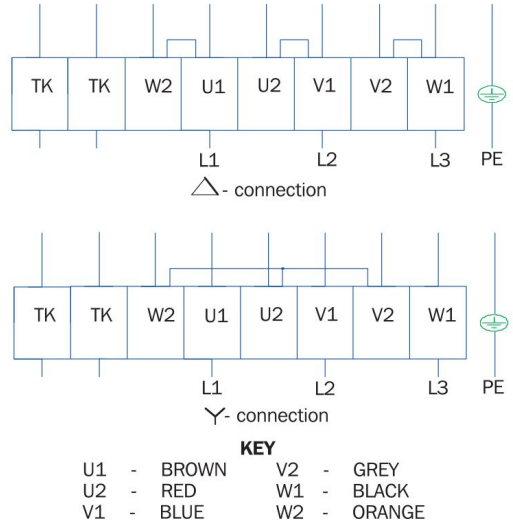

Motor/Fan details

Unit	Phase	Kw	fic	sc	Nominal rpm	max temp	A	B
SMF-350-41	1	0.31	1.35	3.70	1390	40 c	400	360
SMF-400-41	1	0.52	2.20	5.50	1280	40 c	450	390
SMF-450-41	1	0.96	4.30	9.60	1330	40 c	500	440
SMF-500-41	1	1.45	6.10	15.0	1310	40 c	550	470
SMF-350-43	3	0.25	0.46	1.45	1330	40 c	400	360
SMF-400-43	3	0.57	1.05	4.20	1370	40 c	450	390
SMF-450-43	3	0.89	1.65	5.80	1330	40 c	500	440
SMF-500-43	3	1.35	2.30	10.0	1320	40 c	550	470
SMF-560-43	3	2.40	4.30	20.0	1350	40 c	650	510

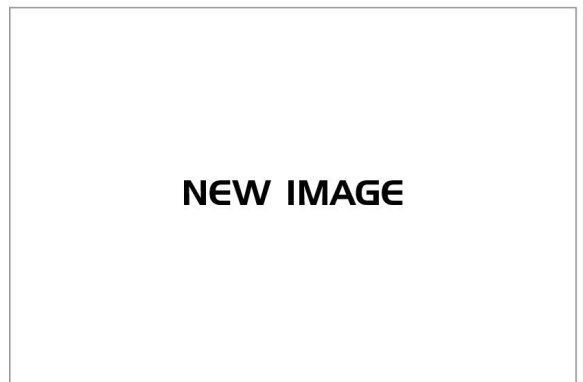

DIMENSIONS & WEIGHTS



All dimensions in MM

	Size	A	B	C	D	E	F	G	H
3ph / 1ph	350	400	452	360	355	395	8	M8	424
3ph / 1ph	400	450	502	390	400	438	12	M8	474
3ph / 1ph	450	500	552	440	450	487	12	M8	524
3ph / 1ph	500	550	602	470	500	541	12	M8	574
3ph only	560	650	702	510	560	605	16	M10	674

TECHNICAL DATA

curve	fan code	phase	Rpm	kW	flc	sc	Octave sound power level L _w A _{REL}								dB
							63	125	250	500	1K	2K	4K	8K	
1	SMFVJ-350-41	1	1390	0.31	1.35	3.70	53	62	67	67	66	65	59	51	73
2	SMFVJ-400-41	1	1280	0.52	2.20	5.50	56	65	70	70	69	68	61	54	76
3	SMFVJ-450-41	1	1330	0.96	4.30	9.60	59	68	73	73	72	71	64	57	79
4	SMFVJ-500-41	1	1310	1.45	6.10	15.0	60	69	74	74	73	72	65	58	80
5	SMFVJ-350-43	3	1330	0.25	0.46	1.45	51	60	65	65	64	63	57	49	71
6	SMFVJ-400-43	3	1370	0.57	1.05	4.20	57	66	71	71	70	69	63	55	77
7	SMFVJ-450-43	3	1330	0.89	1.65	5.80	59	68	73	73	72	71	65	57	79
8	SMFVJ-500-43	3	1320	1.35	2.3	10.0	60	69	74	74	73	72	66	58	80
9	SMFVJ-560-43	3	1350	2.40	4.3	20.0	67	76	80	91	80	79	73	65	87

PERFORMANCE

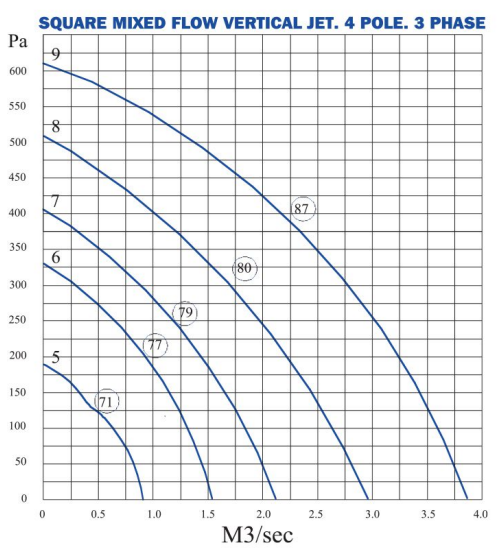
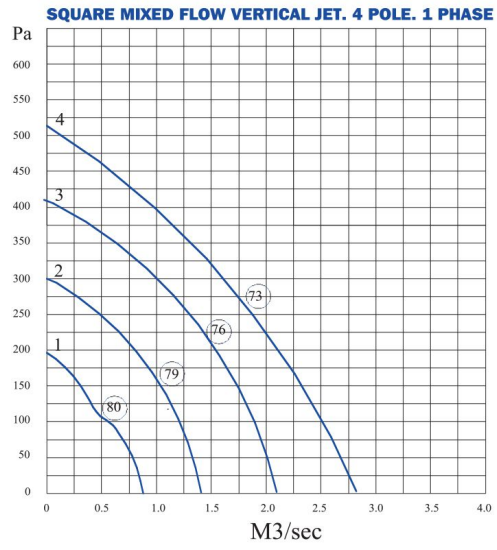

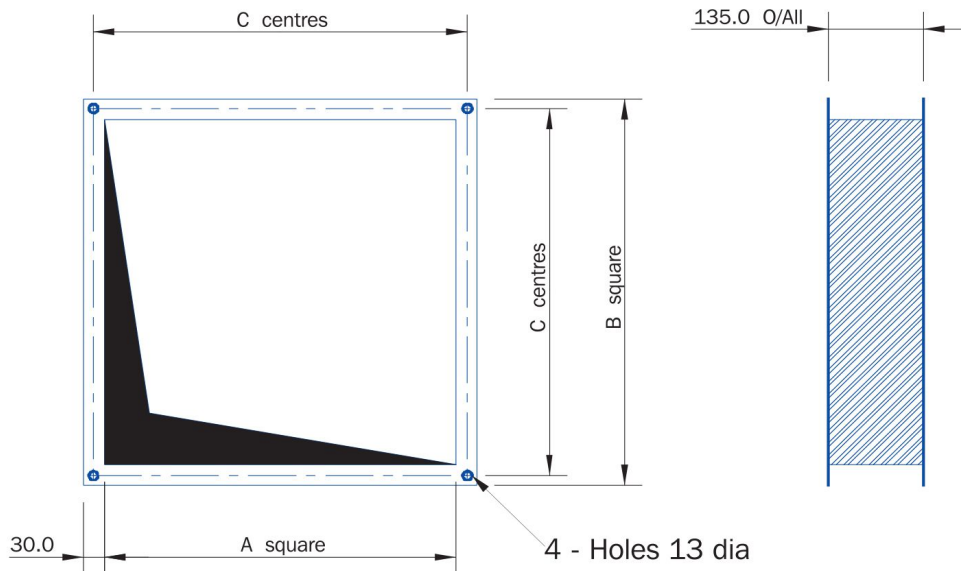

Fan ref	A	B	C
SMFVJ-350	400	460	432
SMFVJ-400	450	510	482
SMFVJ-450	500	560	532
SMFVJ-500	550	610	582
SMFVJ-560	650	710	682

SMFVJ SQUARE MIXED FLOW FLEXIBLE CONNECTION DETAILS

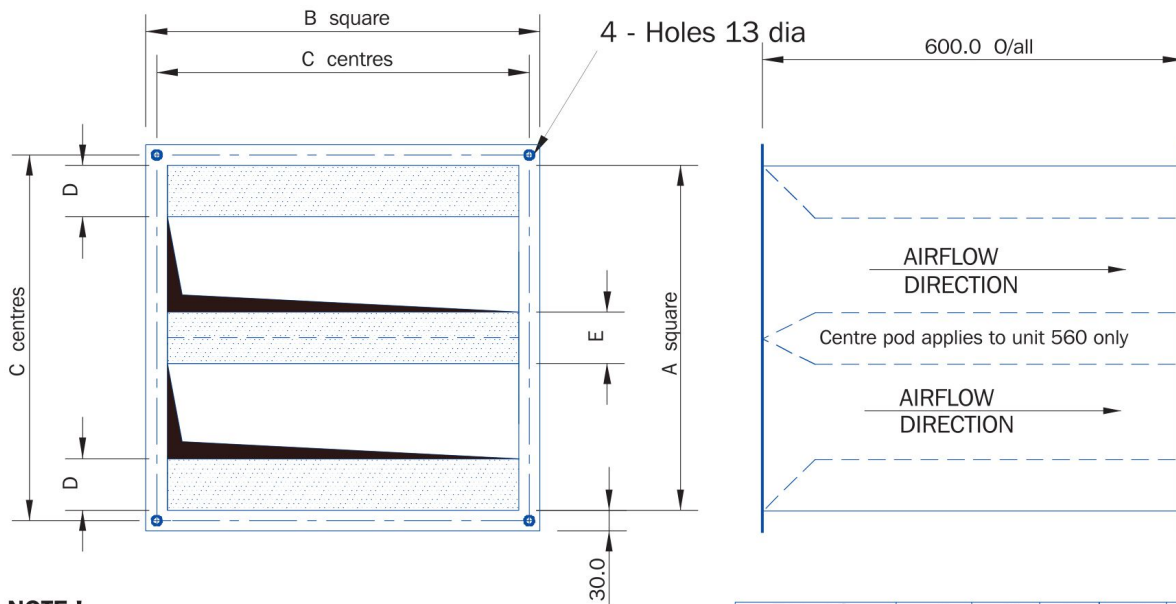

NOTE !
The size 560 has an extra pod in centre = E dimension.

Fan ref	A	B	C	D	E
SMFVJ-350	400	460	432	100	-----
SMFVJ-400	450	510	482	112	-----
SMFVJ-450	500	560	532	125	-----
SMFVJ-500	550	610	582	137	-----
SMFVJ-560	650	710	682	81	162

SMFVJ SQUARE MIXED FLOW ATTENUATOR DETAILS

EC DECLARATION OF INCORPORATION FOR PARTY COMPLETED MACHINERY. (MACHINERY DIRECTIVE 2006/42/EC, ANNEX III.B)

Manufacturer: Moduflow Fan Systems Ltd.
Scarth Road
Sowerby Woods Industrial Estate
Barrow-in-Furness
Cumbria LA14 4RF

Type of Machinery: Fan used for moving air or other gases.

Model: SQUARE MIXED FLOW VERTICAL JET FANS

Manufacturer's Ref / Serial No:

I hereby declare that the Essential Health and Safety Requirements of Directive 2006/42/EC that are listed in Annex 1 of this Declaration are applied and fulfilled and that the relevant technical documentation is compiled in accordance with part B of Annex VII of the Directive.

Relevant information on the partly completed machinery will be supplied electronically or by post, without prejudice to the intellectual property rights of the manufacturer, in response to a reasoned request by the national authorities.

I furthermore declare that fans manufactured by Moduflow Fan Systems Ltd. are driven by AC induction motors and are inherently compliant with the requirements of the Electromagnetic Compatibility Directive (2004/108/EEC) if supplied with a truly sinusoidal AC supply. Where the fan motor is supplied via a frequency converter or other electronic control, verification of compatibility together with cabling should be sought from the control supplier.

This partly completed machinery must not be put into service until the final machinery or installation into which it is to be incorporated has been declared in conformity with the provisions of Directive 2006/42/EC, where appropriate.

Manufacturer's Representative: R P Whitworth. Position: Director

Signature: Date:

ANNEX I (EC DECLARATION OF INCORPORATION FOR PARTY COMPLETED MACHINERY)

Essential health and safety requirements relating to the design and construction of the Partly Completed Machinery.

The following Essential Health and Safety Requirements of Directive 2006/42/EC Annex 1.1, are applied and fulfilled as appropriate:

- 1.1.3 Materials and products
- 1.1.5 Design of machinery to facilitate its handling
- 1.3.1 Risk of loss of stability
- 1.3.2 Risk of break-up during operation
- 1.3.4 Risk due to surfaces, edges or angles
- 1.3.6 Risk related to variations in operating conditions
- 1.5.1 Risk related to electricity supply
- 1.5.4 Errors of fitting
- 1.5.6 Fire
- 1.5.7 Explosion
- 1.5.9 Vibrations
- 1.5.10 Radiation
- 1.5.11 External radiation
- 1.5.13 Emissions of hazardous materials and substances
- 1.6.4 Operator intervention
- 1.7.1 Information and warnings on the machinery
- 1.7.3 Marking of machinery (as appropriate without CE mark)
- 1.7.4 Instructions
 - 1.7.4.1 General principles for the drafting of instructions
 - 1.7.4.2 Contents of the instructions
 - 1.7.4.3 Sales literature

Presumption of conformity with the above listed EHSRs is by application of relevant parts of the following standards:

Applied harmonized standards in particular:
EN ISO 12100-1:2003+A1:2009, EN ISO 12100-2:2003+A1:2009, EN 60204-1:2006+A1:2009, EN ISO 5801:2008 (BS 848-1:2007).

Applied national standards in particular:
BS 848-2.1:2004 (BS ISO 13347-1:2004), BS 848-6:2003 (BS ISO 14695:2003), BS 848-7:2003 (ISO 14694:2003).

INFORMATION FOR SAFE INSTALLATION, OPERATION AND MAINTENANCE OF MODUFLOW LTD VENTILATION EQUIPMENT

To comply with EC Council Directives 2006/42/EC Machinery Directive.

To be read in conjunction with the relevant Product Documentation [see 2.1]

1.0 GENERAL

1.1 The equipment referred to in this Declaration of Incorporation is supplied by Moduflow Ltd to be assembled into a ventilation system which may or may not include additional components.

The entire system must be considered for safety purposes and it is the responsibility of the installer to ensure that all the equipment is installed in compliance with the manufacturers recommendations and with due regard to current legislation and codes of practice.

2.0 INFORMATION SUPPLIED WITH THE EQUIPMENT

2.1 Each item of equipment is supplied with a set of documents which provides the information required for safe installation and maintenance of the equipment. This may be in the form of a Data sheet and/or Installation and Maintenance instruction.

2.2 Each unit has a rating plate attached to its outer casing. The rating plate contains essential data relating to the equipment such as serial number, unit code and electrical data. Any further data that may be required will be found in the documentation. If any item is unclear or more information is required, contact Saverfan.

2.3 Where warning labels or notices are attached to the unit, the instructions given must be adhered to.

3.0 TRANSPORTATION, HANDLING AND STORAGE.

3.1 Care must be taken at all times to prevent damage to the equipment. Note that shock to the unit may result in the balance of the impeller being affected.

3.2 When handling the equipment, care should be taken with corners and edges and that the weight distribution within the unit is considered. Lifting gear such as slings or ropes must be arranged so as not to bear on the casing or impeller/motor.

3.3 Equipment stored on site prior to installation should be protected from the weather and steps taken to prevent the ingress of contaminants.

4.0 OPERATIONAL LIMITS

4.1 It is important that the specified operation limits for the equipment are adhered to e.g. operation air temperatures, air borne contaminants and unit operation.

4.2 Where installation accessories are supplied with the specified equipment e.g. wall mounting brackets or anti-vibration mounts, they are to be used to support the equipment only. Other system components must have separate provision for support.

4.3 Flanges and connection spigots are provided for the purpose of joining to ductwork systems. They must not be used to support the ductwork.

5.0 INSTALLATION REQUIREMENTS

In addition to the particular requirements given for the individual product, the following general requirements should be noted.

5.1 Where access to any part of equipment which moves, or can become electrically live are not prevented by the equipment panels or by fixed installation detail [e.g ducting], then guarding to the appropriate standard must be fitted.

5.2 The electrical installation of the equipment must comply with the requirements of the relevant local electrical standards.

6.0 COMMISSIONING REQUIREMENTS

6.1 General pre-commissioning checks relevant to safe operation consist of the following:

Ensure that no foreign bodies are present within the fan or casing.

Check electrical safety, eg. Insulation and earthing.

Check guarding of system.

Check operation of Isolators/controls.

Check fastenings for security.

6.2 Other commissioning requirements are given in the relevant product documentation.

7.0 OPERATIONAL REQUIREMENTS

7.1 Equipment access panels must be in place at all times during operation of the unit and must be secured with the original fastenings.

7.2 If failure of equipment occurs or is suspected then it should be taken out of service until a competent person can effect repair or examination. [Note that certain ranges of equipment are designed to detect and compensate for fan failure].

8.0 MAINTENANCE REQUIREMENTS

8.1 Specific maintenance requirements are given in the relevant documentation.

8.2 It is important that the correct tools are used for the various tasks required.

8.3 If the access panels are to be removed for any reason the electrical supply to the unit must be isolated.

8.4 A minimum period of 2 minutes should be allowed after electrical disconnection before access panels are removed. This will allow the impeller to come to rest.

NB: Care should still be taken however since airflow generated at some other point in the system can cause the impeller to 'windmill'.

8.5 Care should be taken when removing and storing access panels in windy conditions.